

复合型防火电缆桥架

● 防火水平四通

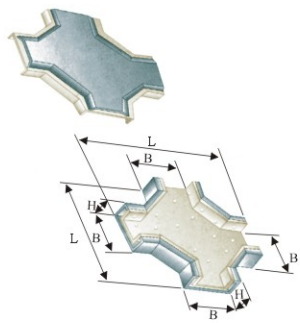

● 防火上垂直四通

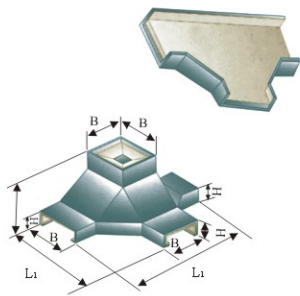

● 防火变径接头

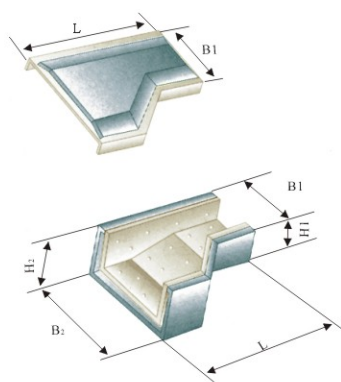

● 防火隔板

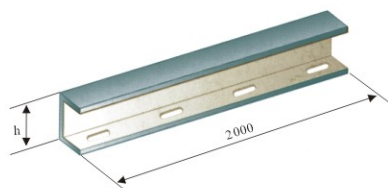

序号	型号	外形尺寸		内截面	
		槽宽	边高	宽 × 高	宽 × 高
1	RQJF-4A	150	100	100	60
2	RQJF-4A	200	100	150	60
3	RQJF-4A	300	100	250	60
4	RQJF-4A	400	100	350	60
5	RQJF-4A	200	150	150	110
6	RQJF-4A	300	150	250	110
7	RQJF-4A	400	150	350	110
8	RQJF-4A	500	150	450	110
9	RQJF-4A	300	200	250	160
10	RQJF-4A	400	200	350	160
11	RQJF-4A	500	200	450	160
12	RQJF-4A	600	200	550	160

序号	型号	外形尺寸		内截面	
		槽宽	边高	宽 × 高	宽 × 高
1	RQJF-4B	150	100	100	60
2	RQJF-4B	200	100	150	60
3	RQJF-4B	300	100	250	60
4	RQJF-4B	400	100	350	60
5	RQJF-4B	200	150	150	110
6	RQJF-4B	300	150	250	110
7	RQJF-4B	400	150	350	110
8	RQJF-4B	500	150	450	110
9	RQJF-4B	300	200	250	160
10	RQJF-4B	400	200	350	160
11	RQJF-4B	500	200	450	160
12	RQJF-4B	600	200	550	160

序号	型号	外形尺寸		内截面	
		槽宽	边高	宽 × 高	宽 × 高
1	RQJF-5A	200	150	150	110
2	RQJF-5A	300	150	250	110
3	RQJF-5A	400	150	350	110
4	RQJF-5A	500	150	450	110
5	RQJF-5A	300	200	250	160
6	RQJF-5A	400	200	350	160
7	RQJF-5A	500	200	450	160
8	RQJF-5A	600	200	550	160
9	RQJF-5A	400	250	350	210
10	RQJF-5A	500	250	450	210
11	RQJF-5A	600	250	550	210
12	RQJF-5A	800	250	750	210
13	RQJF-5A				
14	RQJF-5A				

序号	型号	规格h	配套宽度
1	RQJF-7	40	50
2	RQJF-7	50	60
3	RQJF-7	65	75
4	RQJF-7	90	100
5	RQJF-7	115	125
6	RQJF-7	140	150
7	RQJF-7	190	200
8	RQJF-7	240	250

阻燃玻璃钢电缆桥架

● 产品概述

RQJB阻燃型玻璃钢电缆桥架是以不饱和树脂为主要原料，以玻璃纤维布为主要原料，以玻璃纤维布为增强材料，加入阻燃剂等通过机械化模压和拉挤一次成型而成，它具有高阻燃、耐腐蚀、抗老化、不变形、不吸潮、绝缘性能好、机械强度高、使用寿命长等特点。广泛适用于石油、化工、冶金、电力等行业，电压10KV以下的电力电缆以及控制照明配线等室内外架空、电缆沟、隧道的敷设。

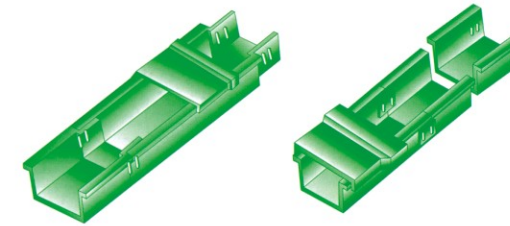

● 阻燃槽式直通桥架(连接板式)

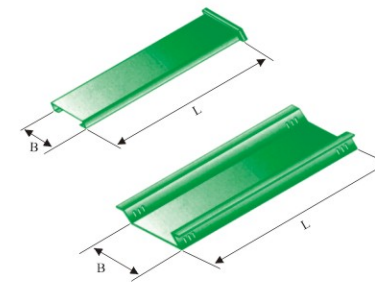

● 阻燃槽式直通桥架(插接式)

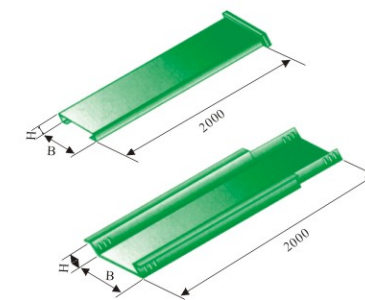

● 阻燃槽式大跨距桥架(插接式)

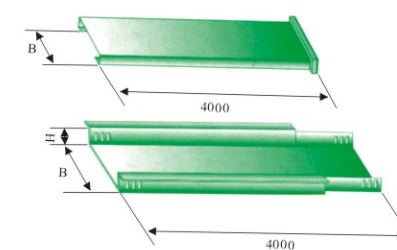

序号	型号	规格B × H	厚度mm
1	RQJB-C-1A ₁	50 × 20	2
2	RQJB-C-1A ₁	100 × 50	2.5
3	RQJB-C-1A ₁	150 × 75	3
4	RQJB-C-1A ₁	200 × 100	3
5	RQJB-C-1A ₁	250 × 125	3.5
6	RQJB-C-1A ₁	300 × 150	3.5
7	RQJB-C-1A ₁	400 × 200	4.5
8	RQJB-C-1A ₁	500 × 200	5.5
9	RQJB-C-1A ₁	600 × 200	6.5
10	RQJB-C-1A ₁	800 × 200	7.5

序号	型号	规格B × H	厚度mm
1	RQJB-C-1A ₂	50 × 20	2
2	RQJB-C-1A ₂	100 × 50	2.5
3	RQJB-C-1A ₂	150 × 75	3
4	RQJB-C-1A ₂	200 × 100	3
5	RQJB-C-1A ₂	250 × 125	3.5
6	RQJB-C-1A ₂	300 × 150	3.5
7	RQJB-C-1A ₂	400 × 200	4.5
8	RQJB-C-1A ₂	500 × 200	5.5
9	RQJB-C-1A ₂	600 × 200	6.5
10	RQJB-C-1A ₂	800 × 200	7.5

序号	型号	规格B × H	序号	型号	规格B × H
1	RQJB-DC-1A ₁	50 × 20	1	RQJB-DC-01A ₂	50 × 20
2	RQJB-DC-1A ₁	100 × 50	2	RQJB-DC-01A ₂	100 × 50
3	RQJB-DC-1A ₁	150 × 75	3	RQJB-DC-01A ₂	150 × 75
4	RQJB-DC-1A ₁	200 × 100	4	RQJB-DC-01A ₂	200 × 100
5	RQJB-DC-1A ₁	250 × 125	5	RQJB-DC-01A ₂	250 × 125
6	RQJB-DC-1A ₁	300 × 150	6	RQJB-DC-01A ₂	300 × 150
7	RQJB-DC-1A ₁	400 × 200	7	RQJB-DC-01A ₂	400 × 200
8	RQJB-DC-1A ₁	500 × 200	8	RQJB-DC-01A ₂	500 × 200
9	RQJB-DC-1A ₁	600 × 200	9	RQJB-DC-01A ₂	600 × 200
10	RQJB-DC-1A ₁	800 × 200	10	RQJB-DC-01A ₂	800 × 200

阻燃玻璃钢电缆桥架

● 阻燃托盘式直通桥架

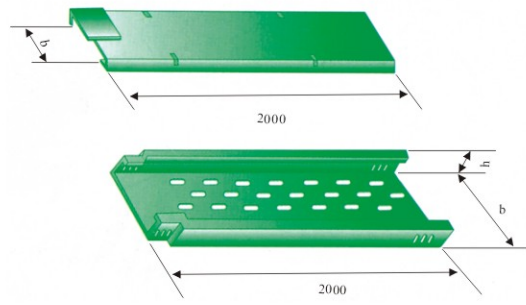

● 阻燃封头



● 阻燃水平弯通

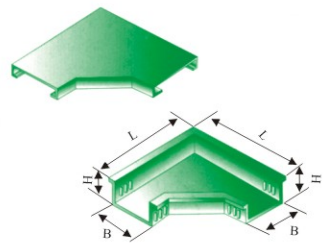

● 阻燃水平三通

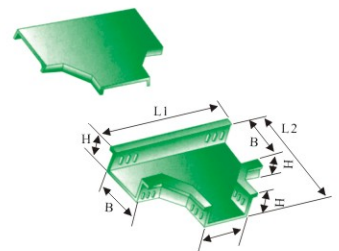

序号	型号	b(mm)	h(mm)	备注
1	RQJB-P-1-6-2	200	60	高度h为60时、100 时，两端各6只连 接孔。
2	RQJB-P-1-10-2		100	
3	RQJB-P-1-15-2		150	
4	RQJB-P-1-6-3	300	60	
5	RQJB-P-1-10-3		100	
6	RQJB-P-1-15-3		150	
7	RQJB-P-1-6-4	400	60	
8	RQJB-P-1-10-4		100	
9	RQJB-P-1-15-4		150	
10	RQJB-P-1-6-5	500	60	
11	RQJB-P-1-10-5		100	
12	RQJB-P-1-15-5		150	
13	RQJB-P-1-6-6	600	60	
14	RQJB-P-1-10-6		100	
15	RQJB-P-1-15-2		150	

序号	型号	规格	
		B × H	B1 × H2
1	RQJB-C-1C-1	50 × 20	43 × 20
2	RQJB-C-1C-2	100 × 50	86 × 44
3	RQJB-C-1C-3	150 × 75	137 × 68
4	RQJB-C-1C-4	200 × 100	184 × 90
5	RQJB-C-1C-5	250 × 125	236 × 114
6	RQJB-C-1C-6	300 × 150	286 × 140
7	RQJB-C-1C-7	400 × 200	386 × 186
8	RQJB-C-1C-8	500 × 200	484 × 186
9	RQJB-C-1C-9	600 × 200	584 × 184
10	RQJB-C-1C-10	800 × 200	782 × 184

序号	型号	规格B × H	长度L	厚度mm
1	RQJB-C-2A-1	50 × 25	200	2
2	RQJB-C-2A-2	100 × 50	250	2.5
3	RQJB-C-2A-3	150 × 75	325	3.5
4	RQJB-C-2A-4	200 × 100	400	3.5
5	RQJB-C-2A-5	250 × 125	475	4.5
6	RQJB-C-2A-6	300 × 150	550	4.5
7	RQJB-C-2A-7	400 × 200	700	4.5
8	RQJB-C-2A-8	500 × 200	800	5.5
9	RQJB-C-2A-9	600 × 200	900	6.5
10	RQJB-C-2A-10	800 × 200	1100	7.5

序号	型号	规格B × H	长度	
			L1	L2
1	RQJB-C-3A-1	50 × 25	325	200
2	RQJB-C-3A-2	100 × 50	400	250
3	RQJB-C-3A-3	150 × 75	500	325
4	RQJB-C-3A-4	200 × 100	600	400
5	RQJB-C-3A-5	250 × 125	700	475
6	RQJB-C-3A-6	300 × 150	800	550
7	RQJB-C-3A-7	400 × 200	1000	700
8	RQJB-C-3A-8	500 × 200	1100	800
9	RQJB-C-3A-9	600 × 200	1200	900
10	RQJB-C-3A-10	800 × 200	1400	1000

● 阻燃水平四通

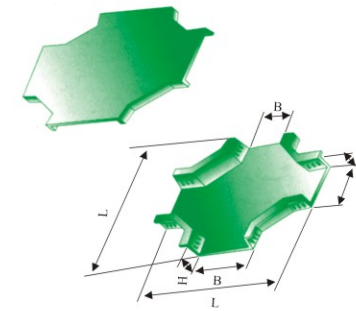

● 阻燃变径接头

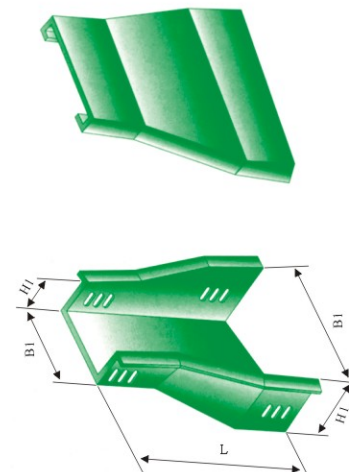

● 阻燃隔板

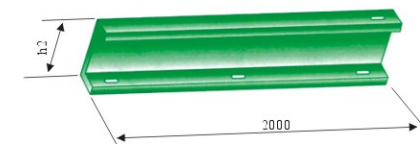

阻燃玻璃钢电缆桥架

序号	型号	规格B × H	长度L(mm)
1	RQJB-C-2A-1	50 × 25	350
2	RQJB-C-2A-2	100 × 50	400
3	RQJB-C-2A-3	150 × 75	500
4	RQJB-C-2A-4	200 × 100	600
5	RQJB-C-2A-5	250 × 125	700
6	RQJB-C-2A-6	300 × 150	800
7	RQJB-C-2A-7	400 × 200	1000
8	RQJB-C-2A-8	500 × 200	1100
9	RQJB-C-2A-9	600 × 200	1200
10	RQJB-C-2A-10	800 × 200	1400

序号	型号	规格B1 × H1-B2 × H2	长度L
1	RQJB-C-5-1	100 × 50-150 × 75	250
2	RQJB-C-5-2	100 × 50-200 × 100	300
3	RQJB-C-5-3	100 × 50-250 × 125	350
4	RQJB-C-5-4	100 × 50-300 × 150	500
5	RQJB-C-5-5	100 × 50-400 × 200	600
6	RQJB-C-5-6	100 × 50-500 × 200	700
7	RQJB-C-5-7	100 × 50-600 × 200	800
8	RQJB-C-5-8	100 × 50-800 × 200	1000
9	RQJB-C-5-9	150 × 75-200 × 100	250
10	RQJB-C-5-10	150 × 75-250 × 125	300
11	RQJB-C-5-11	150 × 75-300 × 150	400
12	RQJB-C-5-12	150 × 75-400 × 200	550
13	RQJB-C-5-13	150 × 75-500 × 200	650
14	RQJB-C-5-14	150 × 75-600 × 200	750
15	RQJB-C-5-15	150 × 75-800 × 200	900
16	RQJB-C-5-16	200 × 100-250 × 125	250
17	RQJB-C-5-17	200 × 100-300 × 150	400
18	RQJB-C-5-18	200 × 100-400 × 200	500
19	RQJB-C-5-19	200 × 100-500 × 200	600
20	RQJB-C-5-20	200 × 100-600 × 200	700
21	RQJB-C-5-21	200 × 100-800 × 200	900
22	RQJB-C-5-22	250 × 125-300 × 100	350
23	RQJB-C-5-23	250 × 125-400 × 125	450
24	RQJB-C-5-24	250 × 125-500 × 150	550
25	RQJB-C-5-25	250 × 125-600 × 200	650
26	RQJB-C-5-26	250 × 125-800 × 200	850
27	RQJB-C-5-27	300 × 150-400 × 200	500
28	RQJB-C-5-28	300 × 150-500 × 200	600
29	RQJB-C-5-29	300 × 150-600 × 200	700
30	RQJB-C-5-30	300 × 150-800 × 200	900
31	RQJB-C-5-31	400 × 200-500 × 200	500
32	RQJB-C-5-32	400 × 200-600 × 200	600
33	RQJB-C-5-33	400 × 200-800 × 200	800
34	RQJB-C-5-34	500 × 200-600 × 200	500
35	RQJB-C-5-35	500 × 200-800 × 200	600
36	RQJB-C-5-36	600 × 200-800 × 200	700

序号	型号	配套高度	h2mm
1	RQJB-C-7-50	50	40
2	RQJB-C-7-75	75	65
3	RQJB-C-7-100	100	90
4	RQJB-C-7-125	125	115
5	RQJB-C-7C-150	150	140
6	RQJB-C-7-200	200	190