

铝合金电缆桥架

● 铝合金下角垂直三通

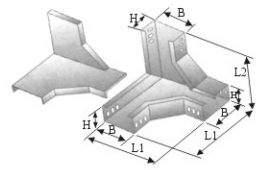

型号	B (mm)	H (mm)	L (mm)	L2 (mm)
RQJL-C-3G-1	50	25	150	125
RQJL-C-3G-2	80	40	280	240
RQJL-C-3G-3	100	50	300	250
RQJL-C-3G-4	120	60	320	260
RQJL-C-3G-5	150	75	350	275
RQJL-C-3G-6	200	100	450	350
RQJL-C-3G-7	250	125	500	375
RQJL-C-3G-8	300	150	650	500

● 铝合金水平四通

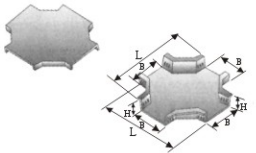

型号	B (mm)	H (mm)	L (mm)
RQJL-C-4A-1	50	25	250
RQJL-C-4A-2	80	40	480
RQJL-C-4A-3	100	50	500
RQJL-C-4A-4	120	60	520
RQJL-C-4A-5	150	75	550
RQJL-C-4A-6	200	100	700
RQJL-C-4A-7	250	125	750
RQJL-C-4A-8	300	150	1000

● 铝合金上垂直四通

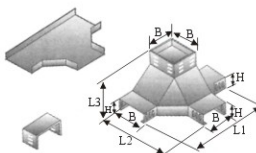

型号	B×H (mm)	B (mm)	L (mm)	L2 (mm)
RQJL-C-4B-1	50×25	250	150	125
RQJL-C-4B-2	80×40	480	280	240
RQJL-C-4B-3	100×50	500	300	250
RQJL-C-4B-4	120×60	520	320	260
RQJL-C-4B-5	150×75	550	350	275
RQJL-C-4B-6	200×100	700	450	350
RQJL-C-4B-7	250×125	750	500	375
RQJL-C-4B-8	300×150	1000	650	500

● 铝合金异径接头

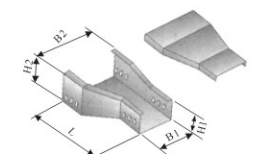

型号	B1×H1 (mm)	B2×H2 (mm)	L (mm)
RQJL-C-5A-1	50×25	100×50	300
RQJL-C-5A-2	80×40	150×75	300
RQJL-C-5A-3	80×40	200×100	300
RQJL-C-5A-4	100×50	200×100	350
RQJL-C-5A-5	100×50	300×150	450
RQJL-C-5A-6	200×100	250×125	350
RQJL-C-5A-7	250×100	300×150	450
RQJL-C-5A-8	250×125	300×150	450

● 铝合金异径接头

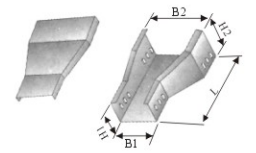

型号	B1×H1 (mm)	B2×H2 (mm)	备注
RQJL-C-5B-1	50×25	100×50	300
RQJL-C-5B-2	80×40	150×75	300
RQJL-C-5B-3	80×40	200×100	300
RQJL-C-5B-4	100×50	200×100	350
RQJL-C-5B-5	100×50	300×150	450
RQJL-C-5B-6	200×100	250×125	350
RQJL-C-5B-7	200×100	300×150	450
RQJL-C-5B-8	250×125	300×150	450

● 铝合金调宽片

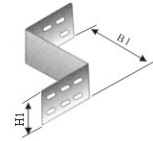

型号	H (mm)	H2 (mm)	L (mm)
RQJL-TPC-01-100			100
RQJL-TPC-01-150	75	50	150
RQJL-TPC-01-200	100	75	200
RQJL-TPC-01-300	150	125	300
RQJL-TPC-01-400	200	175	400
RQJL-TPC-01-500			500

● 铝合金直接片

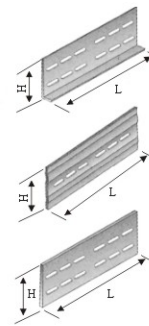

型号	H (mm)	L (mm)	
RQJL-TPC-02-25	15	122	25
RQJL-TPC-02-40	25		40
RQJL-TPC-02-50	30		50
RQJL-TPC-02-60	35	182	60
RQJL-TPC-02-75	50		75
RQJL-TPC-02-100	75		100
RQJL-TPC-02-125	100		125
RQJL-TPC-02-150	125	382	150
RQJL-TPC-02-200	175		200
RQJL-TPC-02-100	70	182	100
RQJL-TPC-02-150	120	382	150
RQJL-TPC-02-200	170		200
RQJL-TPC-02-100	70	182	100
RQJL-TPC-02-150	112		150
RQJL-TPC-02-200	162	382	200

● 铝合金调高片

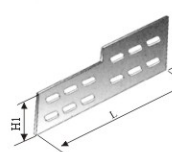

型号	H (mm)	H2 (mm)	L (mm)
RQJL-TPC-03-75/100	50	75	182
RQJL-TPC-03-75/150	50	125	
RQJL-TPC-03-75/200	50	175	282
RQJL-TPC-03-75/150	75	125	
RQJL-TPC-03-75/200	75	175	
RQJL-TPC-03-75/200	75	175	382

● 铝合金弯接片

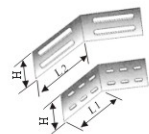

型号	H (mm)	H2 (mm)	L (mm)
RQJL-TPC-04-50	25		
RQJL-TPC-04-75	50	91	200
RQJL-TPC-04-100	75		
RQJL-TPC-04-150	125	191	300
RQJL-TPC-04-200	175		

● 铝合金调角片

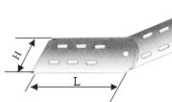

型号	配套桥架高度	H2 (mm)	L (mm)
RQJL-TPC-05-75	75	50	166
RQJL-TPC-05-100	100	75	191
RQJL-TPC-05-150	150	125	341
RQJL-TPC-05-200	200	175	391

● 铝合金隔板



型号	配套桥架宽度	H (mm)
RQJL-PC-07-75	75	40
RQJL-PC-07-100	100	70
RQJL-PC-07-200	150	120
RQJL-PC-07-400	200	170

附件

图形	名称型号	规格
	电缆卡子	
	K-07/30	30 × 50
	K-07/50	50 × 75
	K-07/75	75 × 100
	吊板	
	FJ-01	40 × 50
	吊夹	
	FJ-02/05	L
	FJ-02/100	50, 100

图形	名称型号	规格
	单面缆卡	圆弧直径2R
	K-01/13	13
	K-01/17	17
	K-01/21	21
	K-01/25	25
	K-01/29	29
	吊框	h × h
	FJ-03/80	80 × 80
	FJ-03/130	130 × 80
	吊板	
	FJ-04	30 × 50

附件

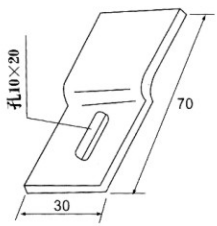
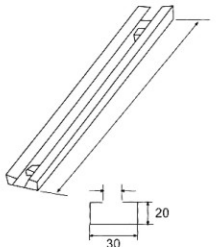
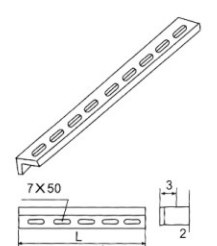
图形	名称型号	规格
	固定压板 T-05	
	槽板 FJ-07/200 FJ-07/400 FJ-07/600 FJ-07/800 FJ-07/1000	200 400 600 800 1000
	花盘角铁 FJ-09/200 FJ-09/600 FJ-09/1000 FJ-09/1500 FJ-09/2000	200 600 1000 1500 2000

附件

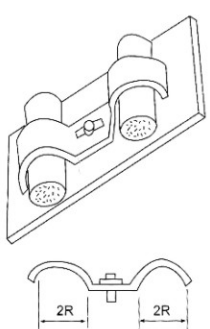
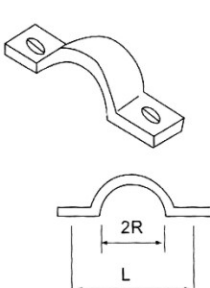
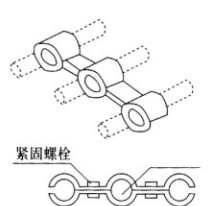
图形	名称型号	规格
	双边单根 电缆卡 K-02/13 K-02/17 K-02/21 K-02/25 K-02/29	圆弧直径 2R 13 17 21 25 29
	双根 电缆卡 K-03/13 K-03/17 K-03/21 K-03/25 K-03/29	圆弧直径 2R 13 17 21 25 29
	缆管卡 K-04/8 K-04/10 K-04/12 K-04/14 K-04/16 K-04/18 K-04/20 K-04/22	管子外径 $\phi 8$ $\phi 10$ $\phi 12$ $\phi 14$ $\phi 16$ $\phi 18$ $\phi 20$ $\phi 22$

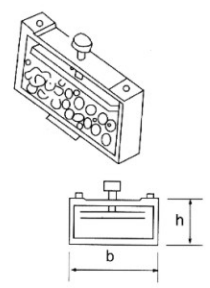
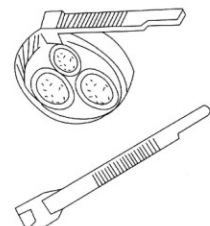
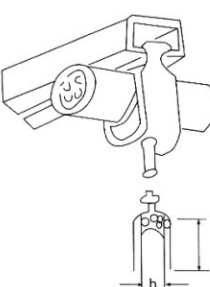
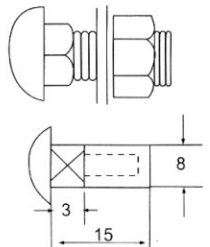
图形	名称型号	规格
	多根电缆卡 K-05/50 K-05/47 K-05/87	$b \times h$ 50 × 50 97 × 47 97 × 87
	电缆卡带 K-06/120 K-06/160 K-06/260	$b \times h$ 120 × 9 160 × 9 260 × 9
	电缆卡子 K-07/30 K-07/50 K-07/75	30 × 50 50 × 75 75 × 100
	方颈连接螺栓 IS-01/6	M8

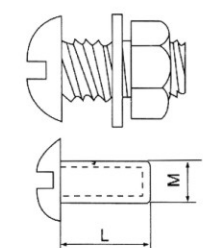
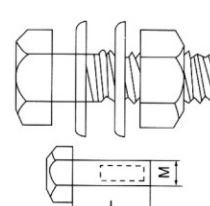
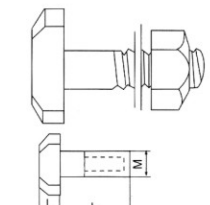
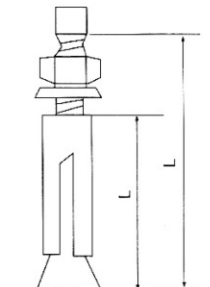
图形	名称型号	规格
	半圆连接螺栓 IS-02/5 IS-02/6 IS-02/8	$M \times L$ M5 × 22 M6 × 22 M8 × 22
	六角连接螺栓 IS-03/10 IS-03/12	$M \times L$ M10 × 25 M12 × 30
	T型螺栓 IS-04/8 IS-04/10	$M \times L$ M8 × 30 M10 × 35
	膨胀螺栓 IS-06/6 IS-06/8 IS-06/10 IS-06/12	M6 × 65 M6 × 80 M8 × 80 M8 × 100 M10 × 95 M10 × 110 M12 × 110 M12 × 130 M12 × 150